

Begane grond 1:100

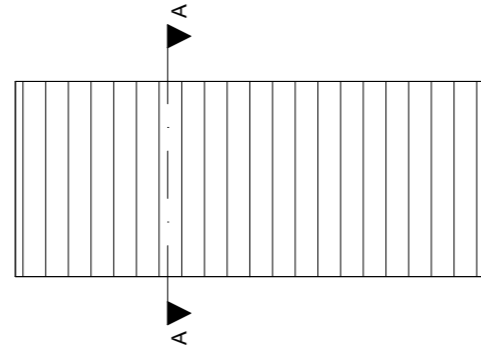

dak 1:100

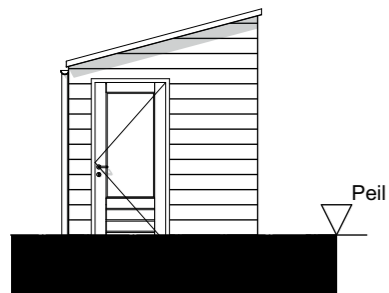

Voorgevel 1:100

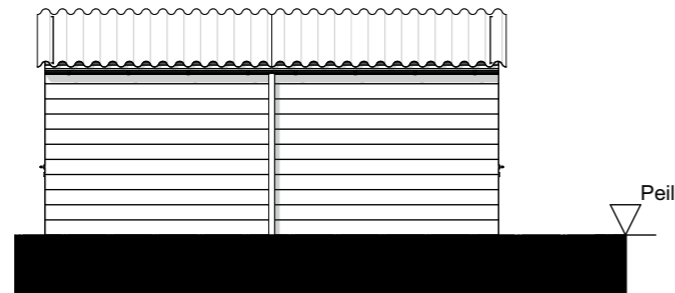

Linkergevel 1:100

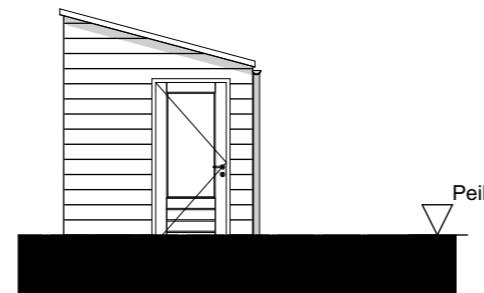

Achtergevel 1:100

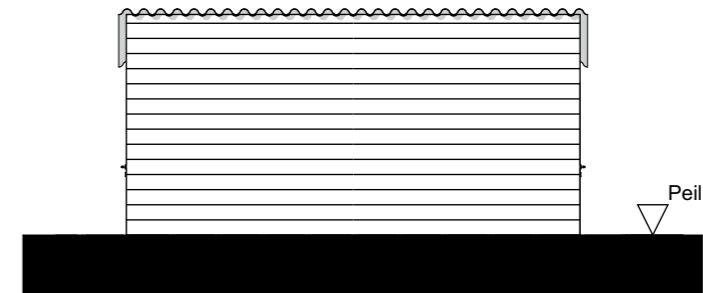

Rechtergevel 1:100

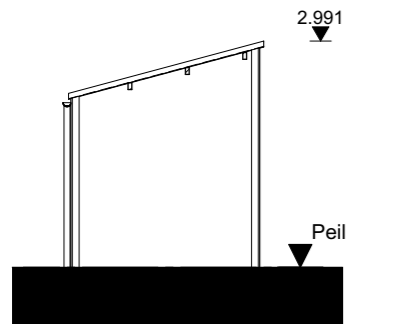

Doorsnede A-A 1:100

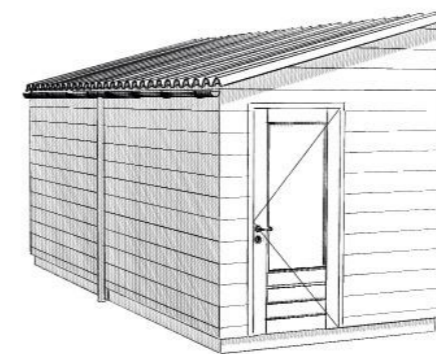

3D voor 1:0,99

ZVA

Zeinstra Veerbeek Architecten

ILSY-Plantsoen 5
2497 GA Den Haag

Telefoon: +31 703478594
info@zeinstraveerbeek.nl
www.zeinstraveerbeek.nl

Project:
Weesperluis, Lanenrijk 2A2;

Fase:
Definitief ontwerp

Schaal:
1:100

formaat:
A3

Datum:
24-07-2020

project nummer:
0453

tekening nummer:
DO-1001

tekening naam:
Berging dubbel

Type:
Berging dubbel

Getekend:
BvdL

